

PATENTS:

2023 3023 3617.8

2015 2001 7468.1

2022 2355 4253.2

2020 3024 3743.8

ONYX

FF 2020C-B

Professional Cordless Hair Clipper

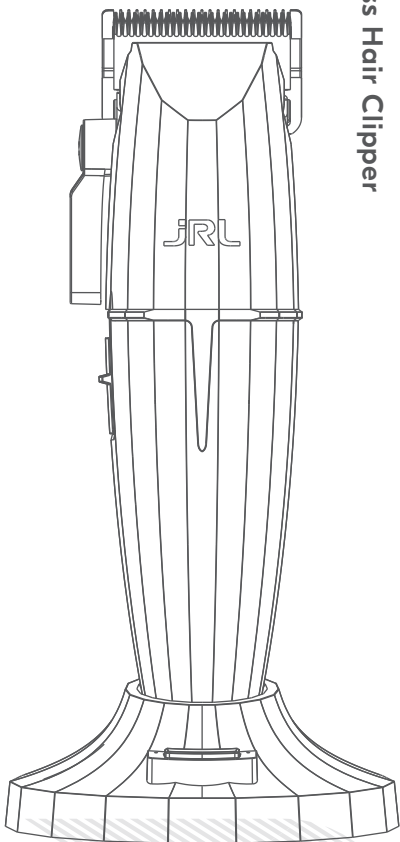

EN

USER'S MANUAL



Tips

1. This machine is not designed to be used on synthetic hair or for any other purpose other than cutting 100% human hair. The company will not take responsibility for malfunctions or damages caused by misuse.
2. This product is designed for professional use only.

Safety precautions

Keep Away from Children:

Please store clipper away from children. Clipper contains sharp blades and small parts that can be harmful to minors.

Safety Use:

1. Unplug the power adapter before cleaning the clipper.
2. Remove the blade first, then use cleaning brush to remove any hair buildup.
3. Keep away from water in order to avoid shock or damage to the clipper.
4. If the clipper is accidentally dropped into water or any other chemicals, discard immediately. Do not try to dry it and plug it into a power source.
5. To properly store, remove clipper from dock, unplug adapter, and thoroughly clean your unit. Do not store the clipper on the charging dock or leave it attached to the adapter.
6. If the cord on the power adapter is damaged, stop using it immediately and replace right away.
7. Do not disassemble this product on your own. Visit authorized dealers for service and repair.
8. Choose the correct voltage socket before charging (AC100-240V 50/60Hz).
9. Please do not twist, disassemble or puncture the rechargeable battery within the clipper, otherwise it may cause a short circuit or burn the machine. If the battery is not working, do not run the clipper and take it to an authorized dealer.
10. Extended use in temperatures below -10°C or above 40°C is not recommended as it may damage the battery.

To Avoid Product Damage:

1. Only use original accessories.
2. Do not sharpen the blade on your own.
3. Only use the original power adapter manufactured by JRL. Using any other adapters from a different company may cause the clipper to malfunction while charging.
4. **WARNING:** For the purposes of recharging the battery, only use the detachable supply unit provided with this appliance.

Product overview

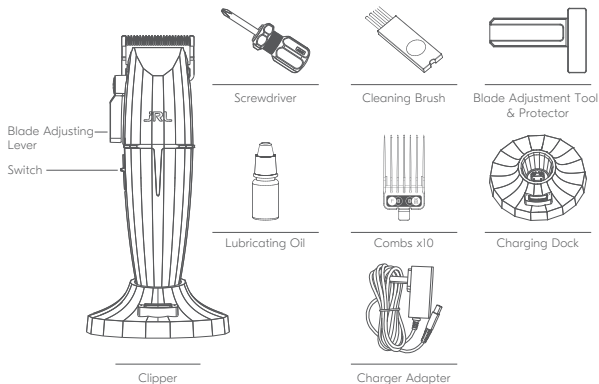

Product specifications

Product code: 2020C-B			
Item	Specifications	Item	Specifications
Power adapter	Input AC 100-240V 50/60Hz	Type of battery	Lithium ion battery
	Output DC 5V 2A	Charging time	2.5 hours for Fast Charging 5 hours for Reset IQ Charge
Battery capacity	3.6V 3500mAh	Usage time	5 hours

How to charge your clipper

Important: Use only original power cord to charge.

You can charge your unit on the portable charging base, or charge the clipper directly by plugging the power cord to the clipper itself.



Note: When the clipper is low on charge, the adapter can be plugged into the clipper directly. You may use the clipper while it is charging.

Reset IQ Technology Charge

Connect charging base to the power adapter, green light turns on. Using the Reset IQ Charge will extend the life of battery and take about 5 hours to fully charge.

Fast Charging Method

Press the button once on charging base to switch to fast charge , white light turns on. The set mode rapid Fast Charging Method takes approximately 2.5 hours.

LED Functions

- When the clipper is not fully charged, the indicator light will continue to flash, and the battery indicator will show the current usable time.
- When the clipper has less than 40 minutes of usable time, the **JRL** warning light flashes in red.
- When the clipper has more than 40 minutes of usable time: **JRL** warning light flashes in white when Fast Charging **JRL** warning light flashes in green when Recovery Charging
- When the clipper is fully charged, the warning light will stop flashing and the white **JRL** light will remain on.

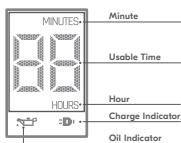
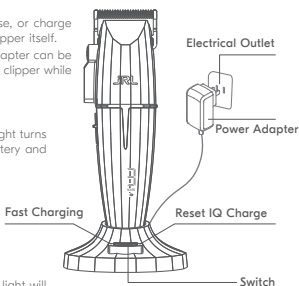

Usage instructions

Switching and shifting instructions:

Push the switch to turn the clipper on and off.

By pushing the switch, the speed of the clipper can also be adjusted:

O: Shutdown (off)

I: Power on / first gear 6000 RPM

II: Second speed 7500 RPM

Clipper status indication by LED light:

The battery indicator shows the usable time of the clipper in the current speed setting.

- When the clipper is in high power mode, the **JRL** white light is on. After an hour of using the clipper, the oil Indicator will prompt.
- When the clipper battery is low, the **JRL** red light will flash.
- Clipper will automatically turn off all the lights and shut down when the battery is dead.

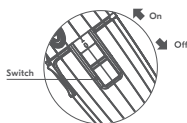

Adjusting the cutting length

The clipper comes with 5 different adjustment levels, which are: 0.5mm, 1.4mm, 2.0mm, 2.8mm, 3.5mm. Users can adjust the level according to their needs.

- Push the blade adjustment lever forward for a closer cut.
- Push the blade back for the reverse effect.



How to install and replace guards

Clipper comes with 10 guards.

Sizes are: 1/2#(1.5mm), 1#(3mm), 1-1/2#(4.5mm), 2#(6mm), 3#(10mm), 4#(13mm), 5#(16mm), 6#(19mm), 7#(22mm), 8#(25mm).

Installing your guard:

As shown in the figure below, align the card slot corresponding to the guard with the main unit of the product, and then lift the main unit gently until you hear a 'click', which indicates the installation of the guard is complete.



Note: Before replacing guard, make sure the clipper is turned off. Make sure the guard is installed properly, and is not loose before use.

Removing your guard:

As shown on the right, you can remove the guard by turning the tail of the comb with your finger.

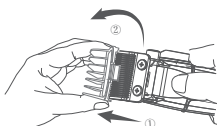

Guard installation

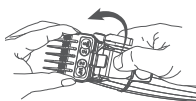

Remove guard method

Blade maintenance



- Note:** 1. Please read the blade maintenance Instructions carefully before operating. Follow the instructions when removing and installing the blade to avoid improper assembly.
2. After the blade is installed, be sure to carefully check whether the corresponding parts have been firmly attached.
 3. Before operating, please unplug the power adapter and turn off the machine.
 4. When handling the blade, do not try to sharpen or alter the blade by yourself to avoid damaging your machine.

Removing the blade:

- Hold the clipper as shown in Figure 1 on the right, loosen the screws shown, and remove the blade.
- When removing the blade, please hold the blade while holding the clipper to prevent the blade from falling and being damaged (caution: the blade is sharp. Pay attention to protect your hands).
- As shown in Figure 2 on the right, remove the upper blade and the movable blade holder together.

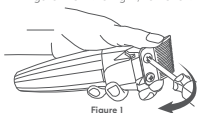

Figure 1

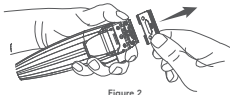

Figure 2

Blade cleaning and maintenance:

Figure 1. Use a brush to clean the main body, the hair debris in the upper and lower blades and the movable blade.

Figure 2. After the cutter head is installed, drip 1-2 drops of lubricant on the corresponding five areas.

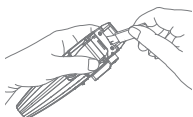

Figure 1

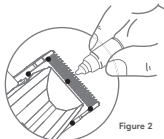
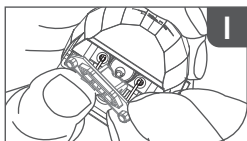
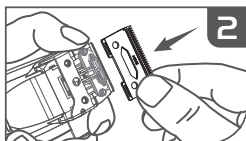

Figure 2

How to install the blade:



1
Install the movable blade on the two pins of the spring attachment.



2
Put the upper blade on the movable blade firmly (no looseness).

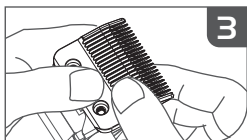

3
The lower blade is pressed down firmly and aligned with the bottom screw hole.

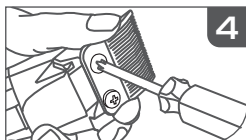

4
Insert the screw clockwise into the 3/4 depth.

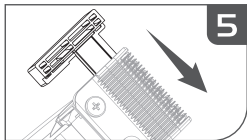

5
Insert the blade adjustment tool. Check that upper and lower blades are centered and parallel.

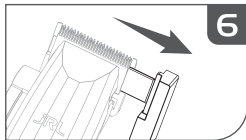

6
Tighten the screws, take out the blade adjustment tool to complete the blade assembly.

Warranty

1. Under normal conditions of proper use and maintenance of the product, the warranty period of the product is 1 year.
2. Expendable parts, such as blades, guards, lubricants, cleaning brushes, etc., are not under the terms of the warranty.
3. The following conditions are not covered by the warranty service:
 - Failure to show a valid receipt/ proof of purchase who is inconsistent with the actual product. Receipt/ proof of purchase must be included
 - Clippers with alterations will not be covered by the warranty service.
 - Failure to follow the instructions in the instruction manual to operate and maintain the clipper, causing it to malfunction or damage it by dropping the clipper, immersing the clipper in water and physical alterations of any kind will void the warranty service.
 - Product damage due to transportation or improper storage.
4. The company will charge a maintenance fee for products without a receipt/ proof of purchase or beyond the warranty period.
5. Please send the clipper in need of repair or warranty to Bratt Trading AB for repair, maintenance, or replacement.



**Guang Zhou Eagle
Fortress Hair Products Ltd.**
No.4 Shuanglong Yucai
Street, Shiling Town, Huadu
District, Guangzhou, 510899,
China

Bratt Trading AB
Radiövägen 34
135 48 Tyresö SWEDEN
+46 (8) 712 95 10
info@bratt-trading.se
www.bratt-trading.com



www.jrl.com



www.bratt-trading.com

